

RZA 11-0355

Technical Data										
RZA 11-	Speed control	Nominal voltage V	Nominal frequency Hz	Nominal motor power kW	Max. power consumption kW	Max. output current (FC) A	Max. operating frequency Hz	Max. fan speed 1/min	Max. media temperature °C	Weight kg
0355-4D	③	400	87	3.60	4.6	7.9	90	2620	40	48

Technical Data										
RZA 11-	Speed control	Nominal voltage V	Mains frequency Hz	Max. power consumption kW	Nominal motor current A	Max. operating frequency Hz	Nominal motor speed 1/min	Max. fan speed 1/min	Max. media temperature °C	Weight kg
0355-4D-50	*	400	50	0.79	2.20	90	1480	2620	40	48
0355-4D-60	*	460	60	1.3	2.40	90	1770	2620	40	48

Frequency Inverter Parameters

The following curves show the fans operating with frequency control: The nominal frequency of the inverter is 87 Hz, i.e. the input frequency 400 V is increased to 87 Hz. The performance curves plot speed/frequency against volume and pressure, and the total efficiency ($\eta_{inverter} \times \eta_{motor} \times \eta_{impeller}$) is expressed as a parabola. The set up parameters for each inverter are provided in the accompanying literature.

Calculations formula

$$P_S = p_{sF} \times q_V / \eta_{sS}$$

$$L_{Wokt7} = L_{WA6/7} + L_{Wrel7}$$

$$L_{Wokt6} = L_{WA6/7} + L_{Wrel6}$$

③ = Stepless speed controllable via frequency converter
 * = No speed control available

Dimensions in mm, Subject to change.

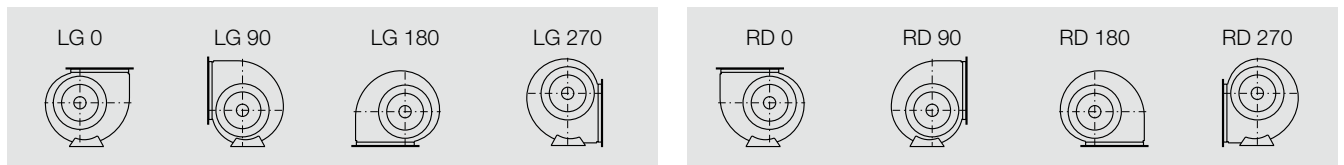
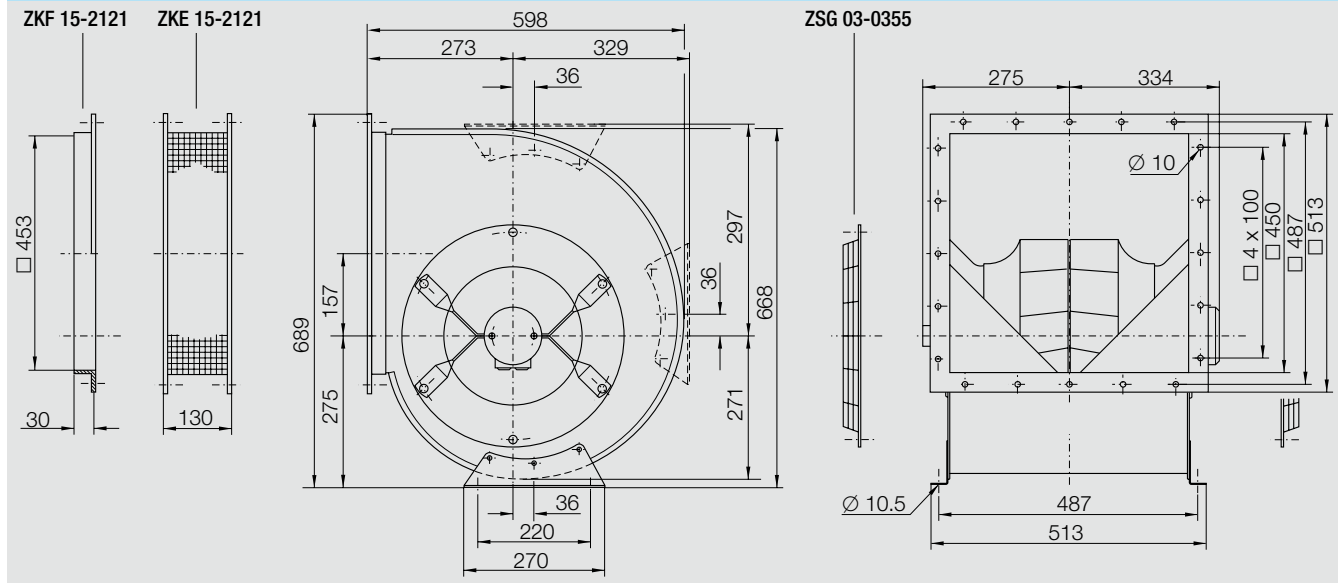

Accessories

RZA 11-	Isolator (metal casing) ESH 22-	Frequency Inverter Unit MM420 for 3~ MM420 3AC 400V	Line Choke for 3~ 6SE6400-	Anti Vibration Rubber Buffers ZBD 01-
0355-4D	ESH 22-075-32	MM420 3AC 400V 4.00KW EMV B	6SE6400-3CC01-4BD3	ZBD 01-0606-A
RZA 11-	ESH 22-	MM420 3AC 400V	6SE6400-	ZBD 01-
0355-4D-50	ESH 22-075-32	-	-	ZBD 01-0606-A
0355-4D-60	ESH 22-075-32	-	-	ZBD 01-0606-A